



R2/500B
BUNK SUPPORT
TRAILER

SBS TRAILERS
com
GREAT BRITISH BOAT TRAILERS



R2/500B

SBS
Difference

Type
Approved

Specification

Design

Versatility

Extras

Contact

Ever since the first SBS Trailer was created in 1957, we have pushed expectations and design. Our trailers have enabled their owners to tow with confidence and launch and recover with ease. They are manufactured from exemplary engineering and construction techniques, which is why we are the recognised leaders in quality and assurance.

SBS, getting you safely from A to B to Sea.



R2/500B

SBS
Difference

Type
Approved

Specification

Design

Versatility

Extras

Contact

R2/500B

The R2/500B un-braked, type approved boat trailer is perfect for boats up to 350kgs and with a length up to 4m when measured from boweye to transom (BET). It offers excellent support for long haul adventures and over winter storage, whilst being easy to launch and recover from, time and time again.



Image for illustrative purposes only

[R2/500B](#)[SBS
Difference](#)[Type
Approved](#)[Specification](#)[Design](#)[Versatility](#)[Extras](#)[Contact](#)

WHY SBS IS GREAT FOR YOU

EXPERTISE

With a boating background, we know boats. We provide a consultative sales process, to make sure you're getting exactly what you need.

LONGEVITY

We are the longest established boat trailer company in the UK. As a result of this we have earned a strong reputation for quality and durability. Which in turn, has resulted in our trailers having the highest market residuals.

BUILD QUALITY

Our build quality is second to none. With a fully welded chassis, we are the only manufacturer to provide a lifetime warranty on the structural integrity of the chassis.

EXCLUSIVE ACCESS

As an SBS customer you will gain exclusive access to discounts, in addition to our technical support line.





WHAT IS A TYPE APPROVED TRAILER?

SBS was the first boat trailer company to achieve whole vehicle type approval back in 2011. The regulation passed into UK law in October 2012 and from that date all manufacturers had to comply.

There is also the National Small Series Approval's (NSS). This is for smaller manufacturers making to the UK standard.

What this means to you as a customer is that you can have confidence buying from a company with these approvals. As they are audited independently, they should operate a professional business, producing a credible product.

We hold both EU and NSS Approvals.

We primarily sell the full EU Type Approved trailer models. This means you are buying a trailer that is ready to be exported and registered abroad or indeed can tow with a local registered car after this process.

But more than that we have spec'd it with some additional equipment that we feel contributes to making the trailer a better, safer option than many alternatives.

Our EU trailers come with a higher specification and include:

- Side LED marker lights as well as a forward facing LED marker lights
- Hub Flush kits to prolong the brakes and braking mechanism
- Padded Side steps for extra grip when boarding/alighting from the boat onto the trailer
- Integrated first level lock within the coupling head



These are all fantastic additions to an already well equipped trailer package.

However, if these features do not appeal to you or add value then please contact our sales team on 01902 754133 and they would be happy to quote for a lesser spec for a UK model.

Make sure you are comparing like for like when you look at other manufacturers as many quote a 'stripped down' version to keep prices low.



SPECIFICATION

Gross Capacity (kg)	500
Load Capacity (kg)	350
Length Capacity (m) (BET)	4
Weight (kg)	150
Dimensions (m)	4.3 x 1.6
Tyre Size	4.00 x 8 x 4PLY

No. of Bunks	2
Length of Bunks (ft)	4
Width of Bunks (mm)	100
No. of Keel Rollers	3
Twin Speed Winch Capacity (lbs)	992
Webbing Strap Width (mm) with snap hook	50

*Specification correct for standard trailer, length can be shortened or extended, 'V' back available for inboard engine boats, and unlimited roller and bunk configurations available.

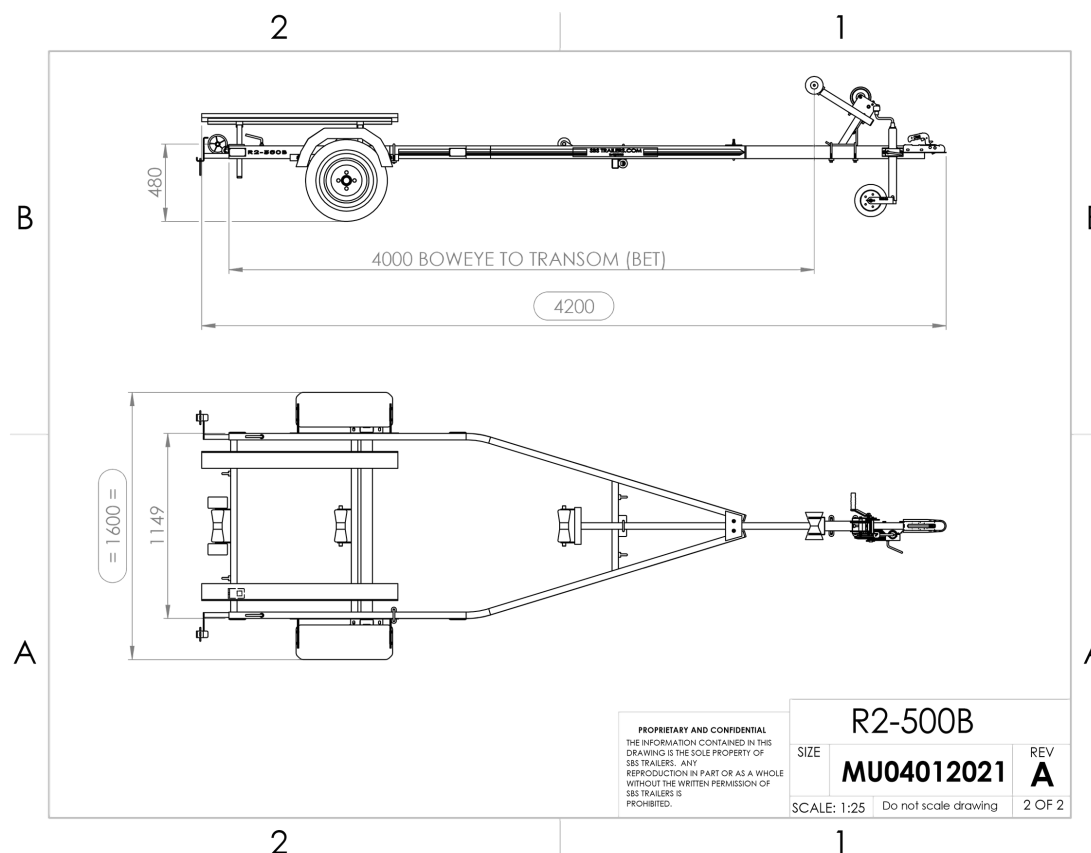
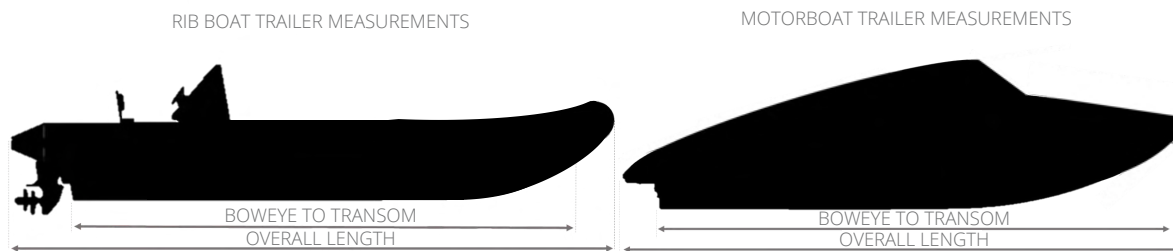

PROPRIETARY AND CONFIDENTIAL THE INFORMATION CONTAINED IN THIS DRAWING IS THE SOLE PROPERTY OF SBS TRAILERS. ANY REPRODUCTION IN PART OR AS A WHOLE WITHOUT THE WRITTEN PERMISSION OF SBS TRAILERS IS PROHIBITED.		
SIZE	R2-500B	REV
	MU04012021	A
SCALE:	1:25	Do not scale drawing
		2 OF 2



R2/500B

SBS
Difference

Type
Approved

Specification

Design

Versatility

Extras

Contact



SECURE LASHING LUGS

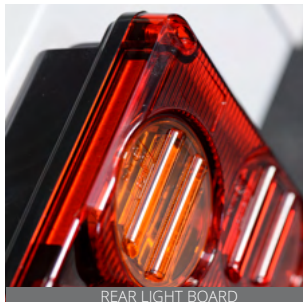

REAR LIGHT BOARD



DOUBLE BOLT SECURE CLAMPING SYSTEM

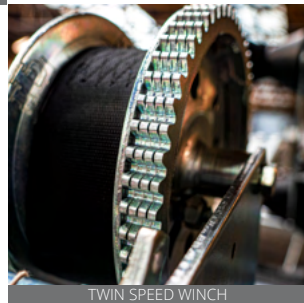

TWIN SPEED WINCH



INTEGRATED LOCK IN COUPLINGS

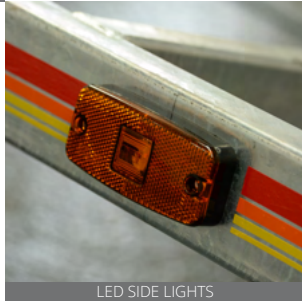

LED SIDE LIGHTS

What's great about our bunk trailers:

- Fully welded A frame ladder style chassis for superior strength.
- Full length keel rollers, offers fantastic support for your boat.
- Height adjustable forward bow roller – for added support and to stop boat pitching during transport
- Fully adjustable side bunks effectively cradle your boat with no pressure spots
- Twin speed winch on adjustable snubber post
- Hot-dip galvanised for ultimate corrosion protection.
- Progressive suspension and sealed bearings for superior towing.
- Axles can be adjusted to ensure optimum nose weight, leading to better, safer towing characteristics.
- LED marker lights - see & be seen.
- Removable rear light board.
- Heavy duty jockey wheel.
- A limited lifetime warranty, unique to SBS.



R2/500B

SBS
Difference

Type
Approved

Specification

Design

Versatility

Extras

Contact



MATERIALS & FABRICATION

Suppliers are carefully chosen to ensure we maintain our superior quality, whilst also using locally sourced premium materials. We cut, weld and assemble all trailers on site. Fully welded trailers are standard across the entire SBS range, so you can be confident in the quality and integrity of your trailer.



UNMISTAKEABLE DESIGN

SBS trailers feature a distinctive signature stripe, designed to enhance your trailer's contemporary appeal. Constructed to last a lifetime, your R2/500B trailer comes with a limited lifetime warranty as standard.*

*Register your trailer within 1 month of purchase, to receive limited lifetime warranty.



R2/500B

SBS
Difference

Type
Approved

Specification

Design

Versatility

Extras

Contact

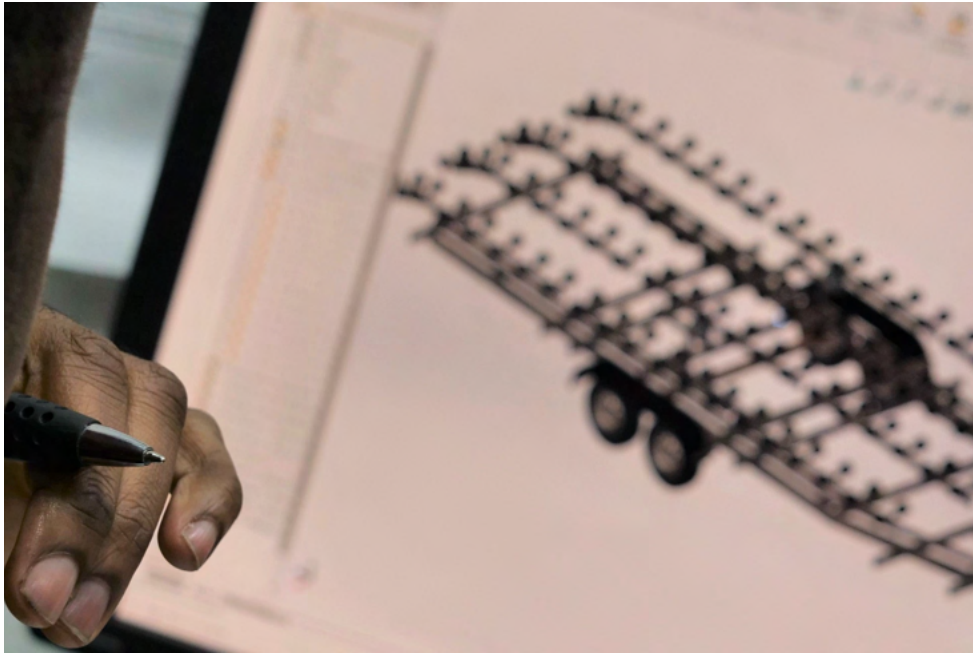

BESPOKE DESIGN

STYLE

We offer customisation of our existing trailer range in addition to fully bespoke trailer builds. We can build our trailers to your boats exact specification to ensure the perfect fit and ultimate support.



CHOOSE YOUR COLOUR

All our trailers can be powder coated or painted in any colour to match your boat or aesthetic.

CHOOSE YOUR WHEELS

We offer a range of wheel in various finishes, to ensure complete personalisation.



R2/500B

SBS
Difference

Type
Approved

Specification

Design

Versatility

Extras

Contact

ULTIMATE ADAPTABILITY

Our trailers are all fully adjustable to ensure the perfect fit to your boat. The axle position, snubber post, winch height and rollers are easily hand adjusted to provide excellent support.

TOW IN CONFIDENCE

All SBS Trailers are fully welded. This provides a stronger, stiffer, safer tow and is far superior to a bolt together trailer. We are the only manufacturer to offer a limited lifetime warranty.

SAFETY

With a removeable rear light board, reflectors, LED side markers* and forward facing white LEDs*, our trailers ensure you can see and be seen.

TYPE APPROVAL

All our trailers conform to the latest type approval legislation. SBS was the first manufacturer in the UK to be awarded type approval for both the UK and EU.

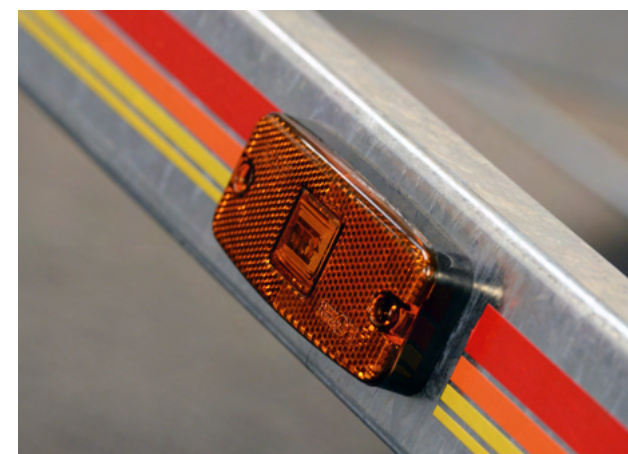

*UK/ EU model dependent.



R2/500B

SBS
Difference

Type
Approved

Specification

Design

Versatility

Extras

Contact

OPTIONAL EXTRAS

Insurance approved wheel lock - We stock a variety of insurance approved wheel locks to fit different wheel widths. All wheel locks are easy to fit and insurance approved, to give you peace of mind.

Float'em poles - Float'em Poles are low profile telescopic guide / docking poles that extend as you enter the water, designed to make launch & recovery easy.

Ratchet straps - With a selection of widths and lengths available, all ratchet straps are manufactured in accordance with British Standards.

Spare wheel & bracket - All our trailers can be fitted with a spare wheel and bracket.

Hub flush kit - All our braked trailers can be fitted with hub flush kits to ensure the longevity of the hub and brakes.

Padded side step - Increased grip and comfort for safer use.

Hitch lock - We stock a variety of insurance approved hitch locks for added security.

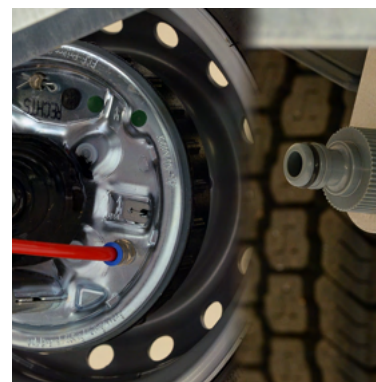



R2/500B

SBS
Difference

Type
Approved

Specification

Design

Versatility

Extras

Contact

CONTACT US FOR FURTHER ADVICE AND INFORMATION

+44 (0)1902 754 133 | SALES@SBSTRAILERS.COM

FOLLOW US



@sbs_trailers



@sbstrailers



@sbstrailersltd

#FollowTheStripe

#GreatBritishBoatTrailers

#SBSTrailers

SBS Trailers, Macrome Rd, Wolverhampton, WV6 9HD

SBS TRAILERS
- .com
GREAT BRITISH BOAT TRAILERS

WWW.SBSTRAILERS.COM

Information and specification in this brochure are subject to change at any time with no notification.